

GenieMat RST

Underlayment for Reduced Sound Transmission



AUSTRALIA EDITION

GENIEMAT® RST

Sound Control Underlayment

FROM THE INVENTOR OF THE PATENTED TECHNOLOGY (US 6920723, US RE41945, CA 2398262) FOR RECYCLED RUBBER USED FOR IMPACT SOUND INSULATION, DIRECTLY BELOW FLOOR COVERINGS.

GenieMat RST is a flat, resilient, reduced sound transmission mat made from 94% recycled rubber content, used directly under hard surface floor finishes and over concrete and wood construction.

It is used when superior sound control is required in residential, education, hospitality, commercial and healthcare high-rises, or commercial buildings and protects ceramic tile, porcelain and stone from substrate cracks.

Engineered for direct adhered floor coverings such as tile, stone, wood, and vinyl floor coverings.

Tile – All products rated for minimum of commercial use.

Wood – **GenieMat FAS** adhesives offer superior bonding strength.

Vinyl – One-step method provides superior sound control for resilient floor coverings.

Features and Benefits:

- Mold, bacteria, fungi, and water resistant
- Exceeds pass criteria for point load test for crack isolation membrane (ANSI 118.12)
- Meets requirements for VOC emissions (IAQ test, ASTM D5116)
- Aids in Part 5.4 Building Code Approval
- Systems can be designed to meet Section 9 of the AAAC "Guidelines for Apartment and Townhouse Acoustic Rating"
- Floorscore® certified
- Complete floor covering system warranty available

PRODUCT SPECIFICATIONS

PRODUCT	ROLL SIZE	AVERAGE DYNAMIC STIFFNESS (BS EN 29052)	TYPE A HARDNESS (ISO 7619-1)	TCNA ROBINSON TEST WITH TILE (ASTM C627)
GenieMat RST02	1.22 m x 22.86 m	157 MN/m ³	40 durometer	Extra heavy commercial
GenieMat RST05	1.22 m x 9.14 m	105 MN/m ³	40 durometer	Moderate commercial
GenieMat RST10	1.22 m x 4.57 m	64 MN/m ³	40 durometer	Light commercial
GenieMat RST12	1.22 m x 4.57 m	60 MN/m ³	40 durometer	Light commercial
GenieMat RST15	1.22 m x 4.57 m	54 MN/m ³	40 durometer	Light commercial

RUBBER IS THE BEST VIBRATION ISOLATION MATERIAL

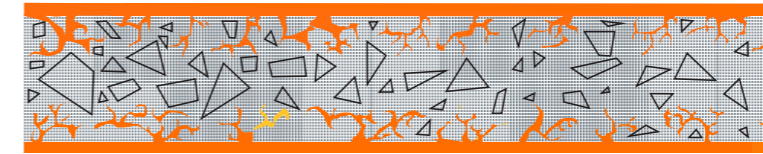

POSITIVE ADHESIVE LOCK
For very high bond strengths with adhered floor coverings.

APPROVED FOR PORCELAIN TILE, VINYL SHEET, LUXURY VINYL PLANK, CERAMIC TILE, AND ALL TYPES OF WOOD FLOOR

Fully Warranted Vinyl Plank System

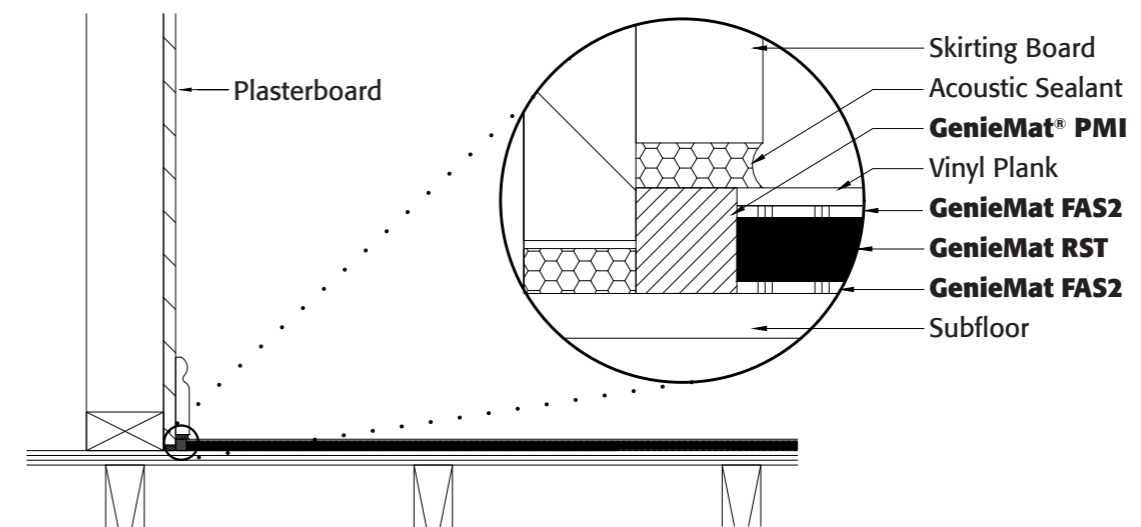

Fully Warranted Ceramic Tile System

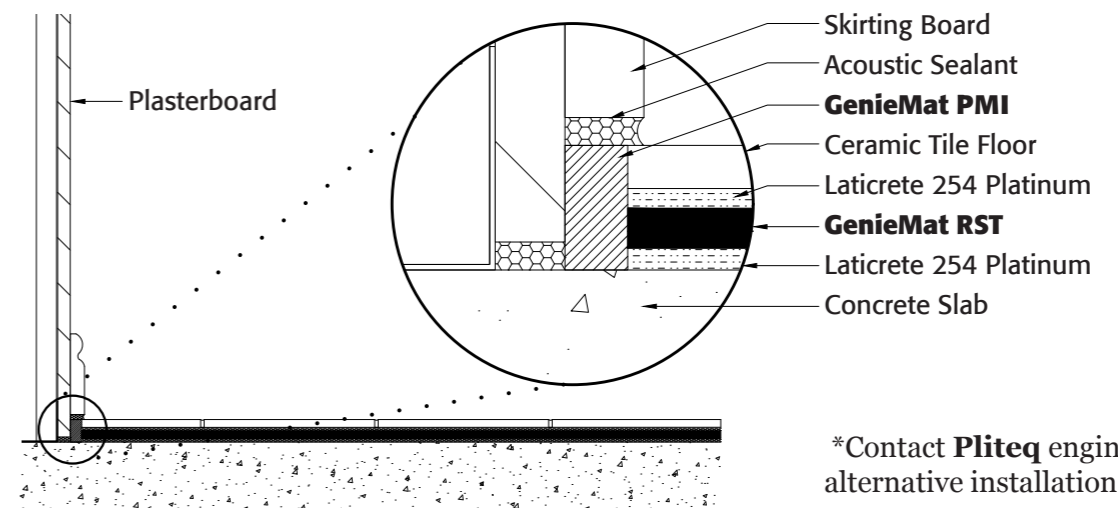

*Contact **Pliteq** engineering for alternative installation methods.

GENIEMAT® RST ACOUSTIC TEST DATA

IMPACT INSULATION SYSTEM

152 mm Concrete Slab

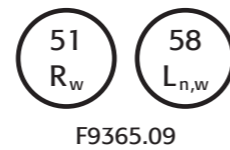
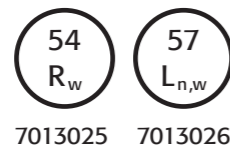
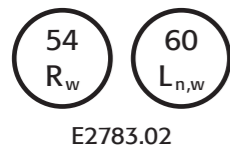
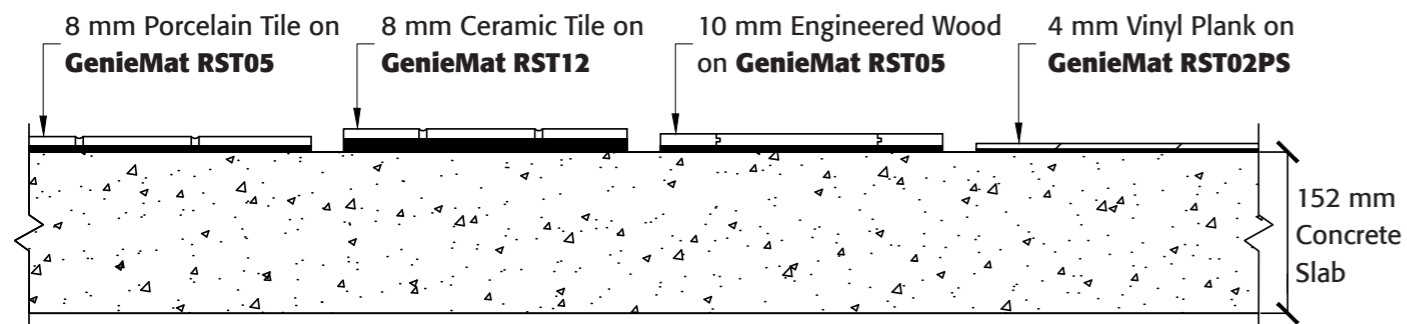

200 mm Concrete Slab

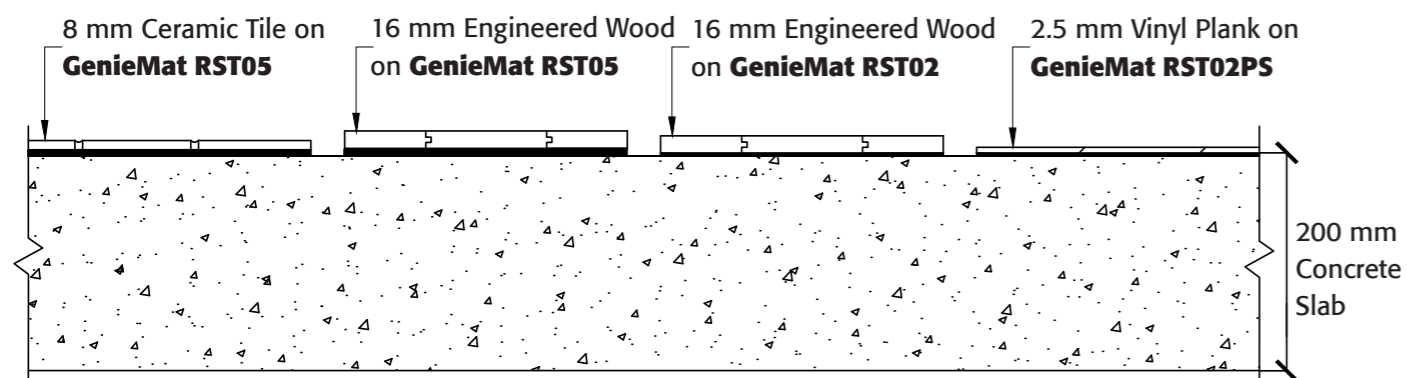

GENIEMAT® RST ACOUSTIC TEST DATA

IMPACT INSULATION SYSTEM

Hollow Core Plank

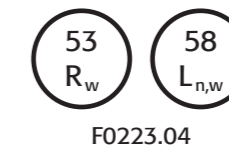
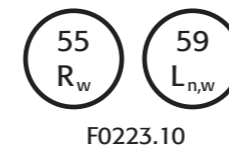
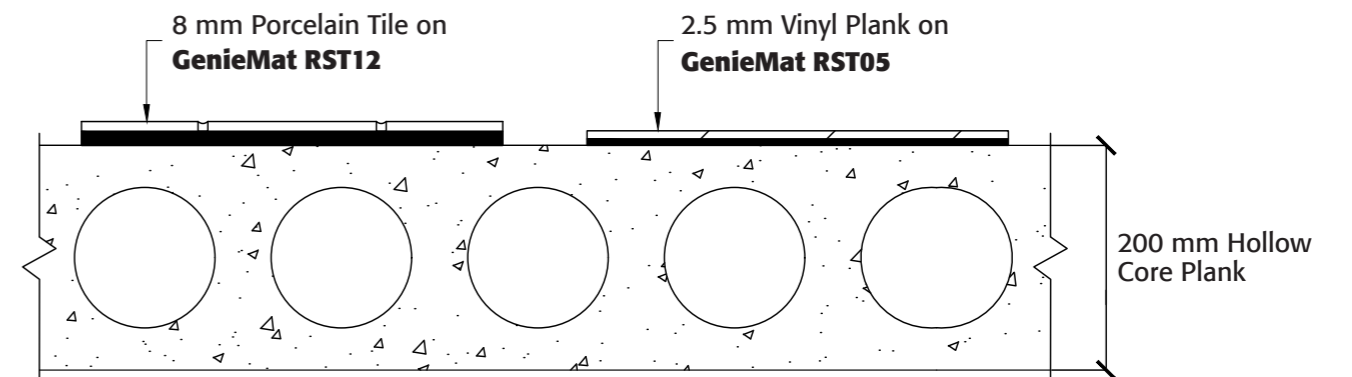

NOTE: No ceiling assembly tested.

Trapezoid Deck

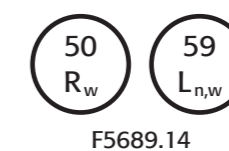
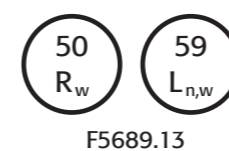
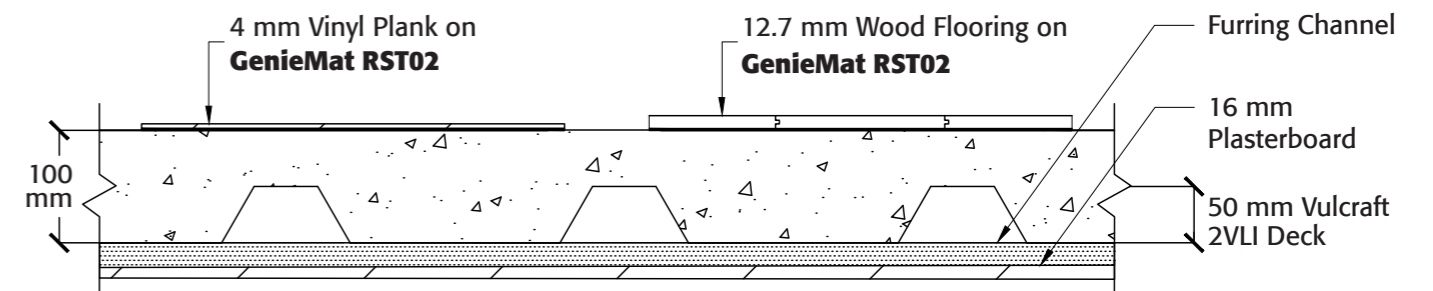

GENIEMAT® RST ACOUSTIC TEST DATA

IMPACT INSULATION SYSTEM

Cross Laminated Timber

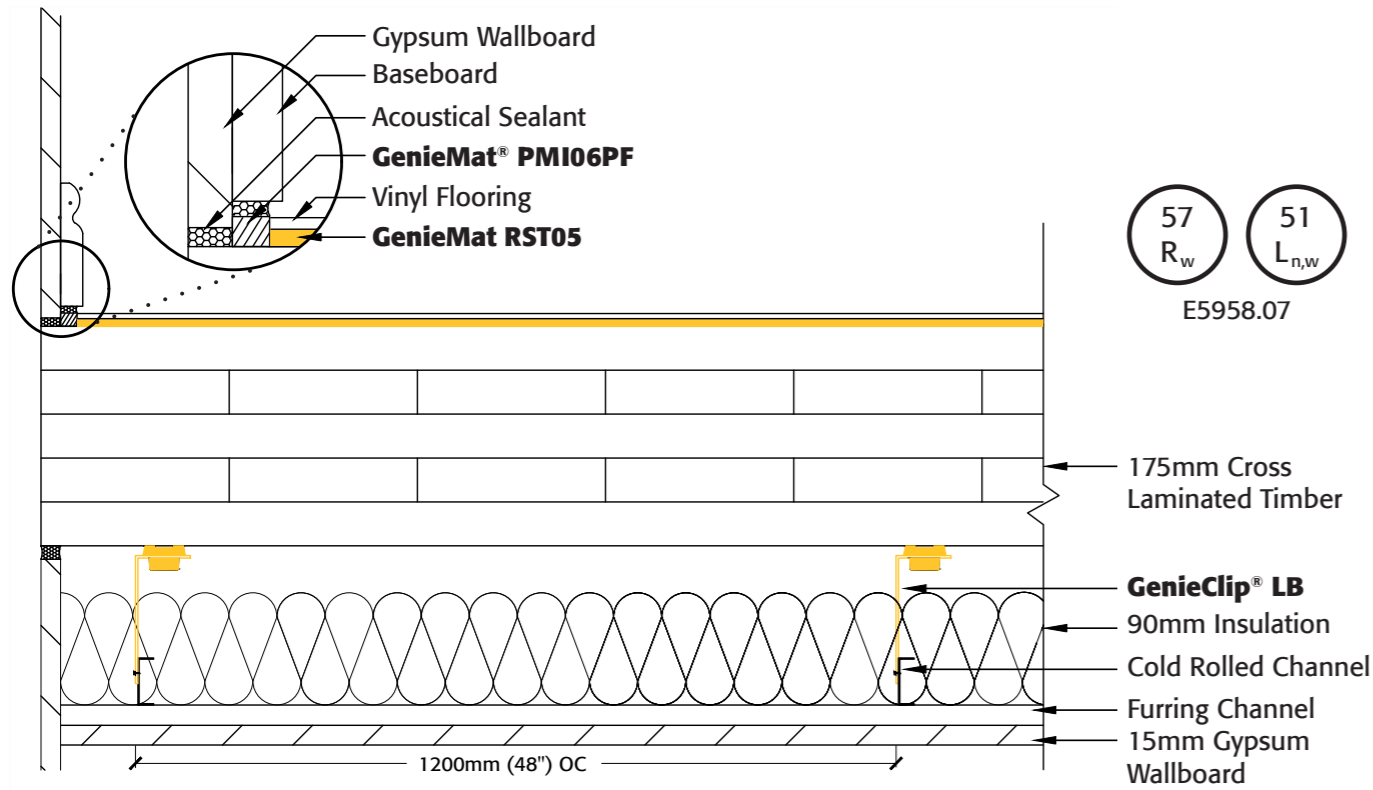

Cross Laminated Timber

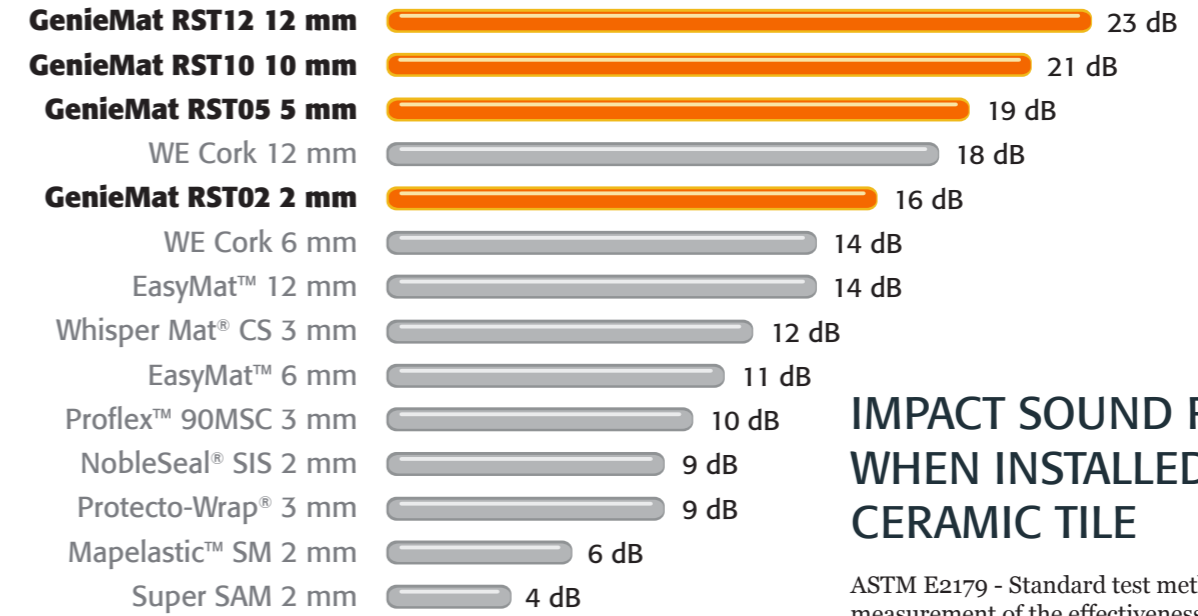
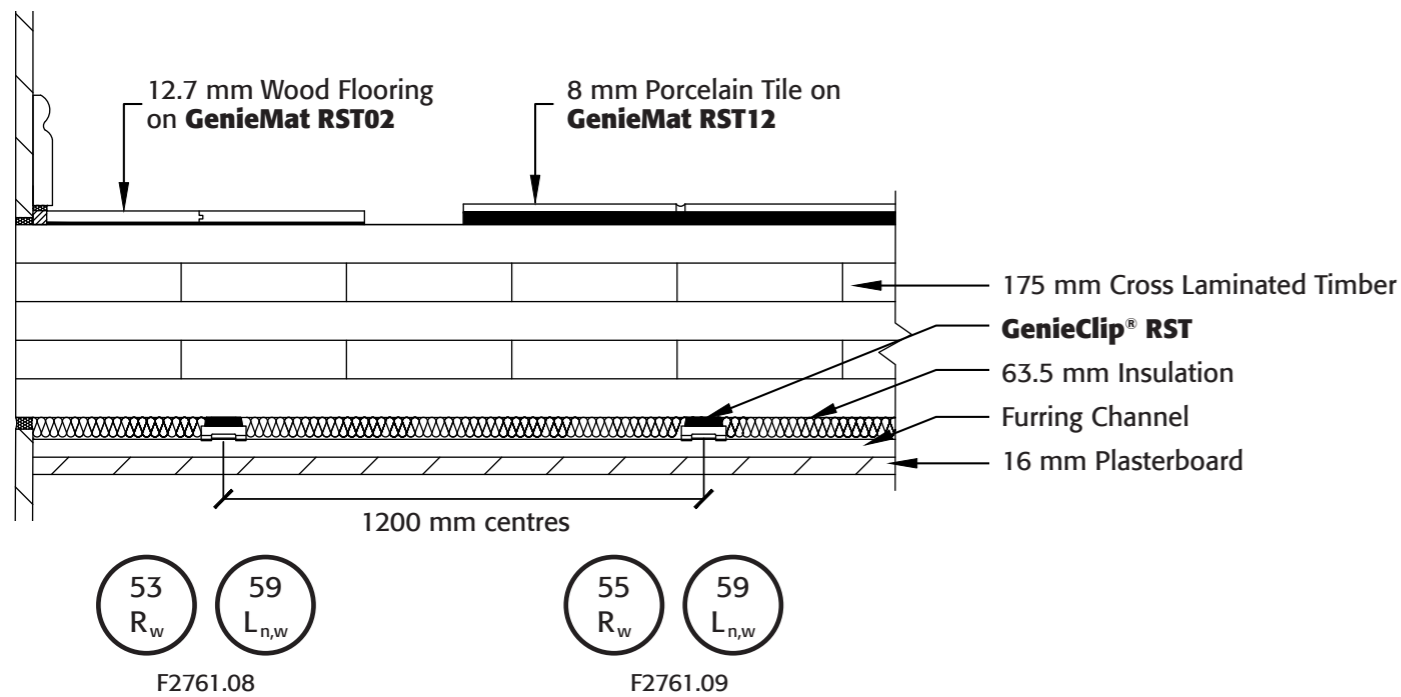

ΔIIC

All listed dimensions are nominal.

IMPACT SOUND REDUCTION WHEN INSTALLED BENEATH CERAMIC TILE

ASTM E2179 - Standard test method for laboratory measurement of the effectiveness of floor coverings in reducing impact sound transmission through concrete floors (150 mm concrete slab with tile).

ACOUSTICAL TESTING STANDARDS - WOOD STRUCTURES

TEST REPORT NUMBER	PRODUCT	FINISH FLOOR	STRUCTURE	SUBFLOOR	CEILING TYPE	R _w	L _{n,w}
G0535.08	GenieMat® RST02PS	Vinyl Plank	Open Web Truss	19 mm Screed, 19 mm OSB	12 mm Resilient Bar, 16 mm Plasterboard	59	60
G0535.07	GenieMat RST02PS	Wood	Open Web Truss	19 mm Screed, 19 mm OSB	12 mm Resilient Bar, 16 mm Plasterboard	60	60
G0535.01	GenieMat RST02PS	Porcelain Tile	Open Web Truss	19 mm Screed, 19 mm OSB	12 mm Resilient Bar, 16 mm Plasterboard	61	58
F4832.18	GenieMat RST02	Porcelain Tile	Engineered Joist	12 mm Plywood, 19 mm OSB	GenieClip® RST, 2x 16 mm Plasterboard	59	55
F5500.03	GenieMat RST02	Vinyl Plank	Engineered Joist	12 mm Plywood, 19 mm OSB	GenieClip RST, 2x 16 mm Plasterboard	60	49
F4832.14	GenieMat RST02	Wood	Engineered Joist	12 mm Plywood, 19 mm OSB	GenieClip RST, 2x 16 mm Plasterboard	58	49
F2761.08	GenieMat RST02	Wood	CLT	None	GenieClip RST, 16 mm Plasterboard	53	59
F2761.09	GenieMat RST12	Porcelain Tile	CLT	None	GenieClip RST, 16 mm Plasterboard	55	59
E5958.07	GenieMat RST05	Vinyl Plank	CLT	None	300 mm Wire Suspended on GenieClip LB, 16 mm Plasterboard	57	51
5013143 7013216	GenieMat RST02	Vinyl Plank	50 x 250 Solid Wood Joist	19 mm Plywood, 12 mm Plywood	GenieClip RST, 12.5 mm Plasterboard	54	59
5013136 7013208	GenieMat RST02	Ceramic Tile	50 x 250 Solid Wood Joist	19 mm Plywood, 12 mm Plywood	GenieClip RST, 12.5 mm Plasterboard	57	58

* RC Deluxe is a brand of resilient bar

TEST RESULTS

ACOUSTICAL TESTING STANDARDS - CONCRETE AND STEEL STRUCTURES							
TEST REPORT NUMBER	PRODUCT	FINISH FLOOR	STRUCTURE	SUBFLOOR	CEILING TYPE	R _w	L _{n,w}
G9222.01	None	Vinyl Plank	200 mm Concrete Slab	None	None	55	67
G9222.04	GenieMat® RST02	Vinyl Plank	200 mm Concrete Slab	None	None	52	53
E8741.01	GenieMat RST12	Ceramic Tile	200 mm Concrete Slab	None	None	57	55
F8530.06	GenieMat RST05	Wood	200 mm Concrete Slab	None	None	55	54
E2783.02	GenieMat RST05	Porcelain Tile	150 mm Concrete Slab	None	None	54	60
F9365.09	GenieMat RST02PS	Vinyl Plank	150 mm Concrete Slab	None	None	51	58
G2953.07	GenieMat RST05	Wood	150 mm Concrete Slab	None	None	52	57
F0223.10	GenieMat RST12	Porcelain Tile	200 mm Hollow Core Plank	None	None	55	59
F0223.04	GenieMat RST05	Vinyl Plank	200 mm Hollow Core Plank	None	None	53	58
G3991.07	GenieMat RST05	Porcelain Tile	140 mm Trapezoidal Steel Deck	None	GenieClip® RST, 16 mm Plasterboard	56	59
G3991.17	GenieMat RST02	Wood	140 mm Trapezoidal Steel Deck	None	Furring Channel	54	58
F9365.02	GenieMat RST05	Porcelain Tile	100 mm Trapezoidal Steel Deck	None	GenieClip RST, 2x 16 mm Plasterboard	58	59
F5689.07	GenieMat RST02	Vinyl Plank	100 mm Trapezoidal Steel Deck	None	GenieClip RST, 16 mm Plasterboard	54	56
F5689.06	GenieMat RST05	Wood	100 mm Trapezoidal Steel Deck	None	GenieClip RST, 16 mm Plasterboard	56	56
F5689.18	GenieMat RST12	Porcelain Tile	250 mm Steel Joist	19 mm Structural Concrete Panels	GenieClip RST, 2x 16 mm Plasterboard	62	60
F5689.20	GenieMat RST02	Vinyl Plank	250 mm Steel Joist	19 mm Structural Concrete Panels	GenieClip RST, 2x 16 mm Plasterboard	60	58
F5689.21	GenieMat RST02	Wood	250 mm Steel Joist	19 mm Structural Concrete Panels	GenieClip RST, 2x 16 mm Plasterboard	59	57
F3052.15	GenieMat RST10	Porcelain Tile	400 mm Insulated Concrete Form	None	12 mm Plasterboard	56	59
F3052.14	GenieMat RST05	Wood	400 mm Insulated Concrete Form	None	12 mm Plasterboard	54	57